

Pé nivelador sextavado

Tipo: PNS

Polipropileno / Rosca Aço Zincado

Desenho Técnico

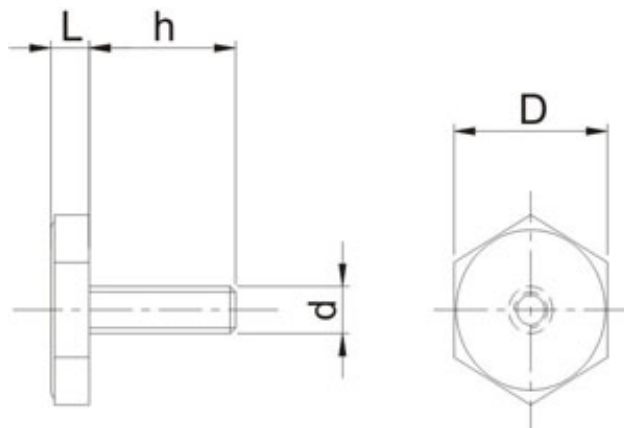

Modelos e Especificações Técnicas

Código	D	L	h	d
PNS-2208-1/4"X19	22	9	19	1/4" UNC-20
PNS-3515 M10x32	32	15	30	M10x1.5
PNS-3520 1/2x40	32	21	40	1/2" UNC-13

REI-FIX - Tel. (11) **2602-2626**